

# The Architectures of SMS Management System as a Tool for Communication

Azmi Md Saman, Shafiz Affendi Mohd Yusof, Salman Sha'ri

*Applied Science, College of Art and Sciences  
Universiti Utara Malaysia, 06010 Sintok, Kedah, Malaysia  
Email: {azmi1326, shafiz, salman}@uum.edu.my*

## ABSTRACT

*This paper describes the characteristics, advantages and disadvantages of a SMS Management System to be used in the educational environment. This system is hoped to encourage communication among lecturers and students in the teaching and learning process. The context of the study was carried out at Universiti Utara Malaysia, Sintok, Kedah as higher learning institution in Malaysia and the study focused on the teaching and learning process in the Division of Applied Science, College of Arts and Sciences (CAS). The motivation of the study is due to undergraduate students having to deal with many issues relating to academic difficulties such as instance communication with lecturers regarding matters such as assignments, group projects, quizzes and examination problems. Therefore, the SMS Management System architecture will be explored to identify what are the main elements and characteristics that must exist in designing and developing an Academic Alert System (AAS) concerning with academic management environment.*

### Keywords

*Short Messaging Service (SMS), SMS Management System, Alert System, Academic Environment, Telecommunications Protocols.*

## 1.0 INTRODUCTION

Mobile devices such as mobile phones enable its subscribers to receive several service for communication such as voice, voice mail, alphanumeric text through Short Messaging Service (SMS), Multimedia Messaging Service (MMS) and now with new features that is third generation wireless protocol (3G) for mobile communication systems, and video mail. In the mobile communication systems, it involves a lot of wireless protocol networks like Wireless Application Protocol (WAP), Global System for Mobile Communication (GSM), General Packet Radio Service (GPRS), and Wireless Markup Language (WML). All wireless protocols mentioned above are very important for supporting mobile communication during transmission. Nyuk Mee and Selamat (2007), cited that SMS Management System and Information Management System are concepts in mobile technology. On the other hand, in mobile telecommunication network, the

SMS service was created to transmit short messages that contain useful data (Nyuk Mee, and Selamat, 2007).

Nowadays, mobile technology has assisted the learning and teaching process in the educational environment (Eteokleous, 2006). As an example, using SMS service lecturers are able to alert the student the submission date for a given assignments are approaching to assist the student better manage and organise their learning schedule to meet the deadlines (Issack, Hosany, & Gianeshwar, 2006).

## 2.0 MOTIVATION OF THIS STUDY

There are two problems identified during the making of AAS architecture; especially in the design and development processes. We analyzed a few SMS Management System in the market to were consider the academic environment so that the system designed and developed later could facilitate more communication among student and lecturer in teaching and learning processes.

Several models of the SMS Management System in the current market were identified and inspected, for example the Bulk SMS, SMS4Mail, Ping SMS, Short Messaging Service Center (SMSC) Kernel, and SMPP Server. This study is intended to explore the existing architecture of SMS Management System and to gather important requirement concerning of suitability in academic communication environment.

## 3.0 REVIEW OF CURRENT SMS ALERT SYSTEM

Generally, mobile phones have two main services which are voice and SMS. These services involved several wireless protocols in mobile communication network such as WAP, MAP, GSM, and other protocols. This study will examined several wireless protocols and components in mobile transmission process.

### 3.1 Bulk SMS Messaging

Bulk SMS messaging is one of the service that was created by Clickatell (2005), and it is the simplest and easiest way to

send SMS to recipients. As an example, the process of sending SMS messages include selecting the recipient or group, typing the message and then sending it. This alert system was developed using a web-based application and it is totally free to use, but users' requires to pay per message sent and first need to register before using it. The interface and system were designed with ease of use and each message sent from this service can be modified to include the name of the recipient. In addition, the sender ID number can be set to either a number or name, such as the name of company. The following figure 1 shows an interface of this service.



Figure 1: The Interface of Bulk SMS Messaging (Clickatell, 2005).

### 3.2 Oracle Application Server Wireless (OASW)

Oracle Application Server Wireless is one of the components of Oracle Application Server (Clickatell, 2005). It offers a broad platform for extending the reach of the enterprise applications by providing a highly scalable device to deliver messages using mobile devices. A lot of applications have been included in the mobile messaging such as system alerts, notifications, information and content services.

XMS web service and SMPP service are two methods used to connect the OASW with Clickatell messaging gateway and both of the services involved default drivers, and requiring a permanent Internet access. The following figure 2 as general architecture of SMS Management System is produced by Clickatell.

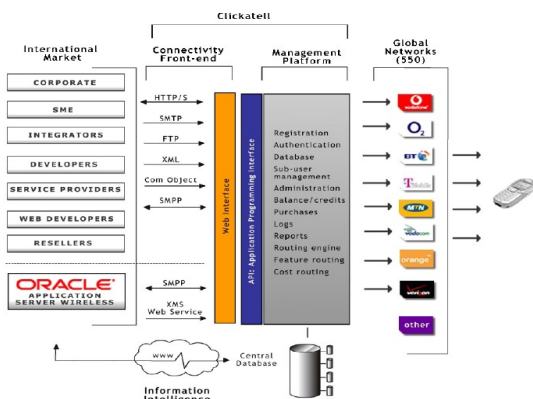
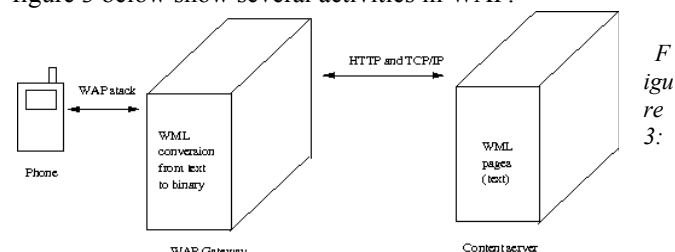

Figure 2: The Architecture of Alert System (Clickatell, 2005).

### 3.3 Wireless Application Protocol (WAP)

The Kannel open source WAP and SMS gateway (Kannel, n.d.) defined WAP as a collection of languages, tools and an infrastructure for implementing services for mobile phones and makes it possible to implement services using hypertext, similar to the World Wide Web. WAP can be divided into two protocols which is WAP push and WAP pull.

The Wireless Markup Language (WML) is completely a new markup language for the hypertext browser in the phone to interpret and display it compared to HTML. The following figure 3 below show several activities in WAP.



WAP Architecture (Kannel, n.d.).

### 3.4 Short Messaging Service Center (SMSC) Kernel

According to IMImobile (2005), mentioned the SMSC Kernel can accept SMS services from mobile network, and application and then delivers it to multiple destinations. The SMSC kernel will managed the entire pending message in the queue and it involves several component such as messaging queue manager, router and generates billing information.

#### 3.4.1 SS7 Server

As explained by IMImobile (2005), the SS7 Server will allow interconnection with mobile networks in the Mobile Application Protocol (MAP) layer, GSM network, IS-41 layer and CDMA/TDMA networks.

#### 3.4.2 Short Message Client Interfaces (SMCI)

The SMCI allows other applications to connect to the SMSC Kernel as well as it enables the operator to provide extensive value added services (IMImobile, 2005). The interfaces of SMCI include the GUI Interface, MAP Interface, GMSC/IWMSM Interface, HTTP Interface, TCP/IP Interface, File Based Interface, SMTP Interface and POP3 Interface.

#### 3.4.3 SMPP Server

IMImobile (2005) cited that the role of SMPP Server as a receiving mobile that consists of originated SMS messages, replying to prior email messages and SMS notifications. Profiles or conversion process will be used for extracts destination email addresses from the SMS and it describe how

to handle notification messages returned by remote SMSCs in response to previously sent email-to-mobile messages.

### 3.4.4 Billing Server

According to IMImobile (2005), a Billing Server will be able to generate charging information and also allows enabling or disabling of individual CDRs.

### 3.4.5 CDR Generator

IMImobile (2005) stated that the CDR Generator is responsible to keep a record during calls process and then it will generate CDR data in an ASCII format such as MSISDN number, time stamp, MT/MT, and DCS.

### 3.4.6 Database Server

IMImobile (2005), explained that Database Server are used as data achieve and it based on Oracle 9i.

### 3.4.7 Admin Console

IMImobile (2005), mentioned that Admin Console is responsible in operation, maintenance, configuration and start or stop monitoring of all the SMSC components.

The following figure 4 shown the Short Messaging Service Center (SMSC) architecture that applied by IMImobile (2005), and it involved several mobile protocols before and after message are received by recipient.

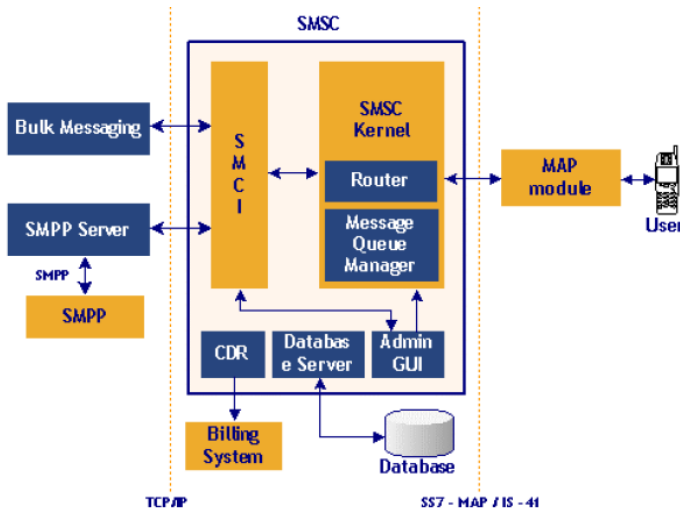

Figure 4: SMSC Architecture (IMImobile, 2005).

### 3.5 Ping Alert Version 1.2

According to SMS4Mail (n.d.), Ping Alert is a useful alert system that can automatically alert (ping) someone by using

email or sending SMS. This alert system will send e-mail or send an SMS alert when there is a Ping timeout and it allows user to set numbers of packs, bytes of packets, and time intervals. This application is a standalone program; where user is required to install the software first and configure a setting such as add host name, put mail server name, email account, and password.

The following figure 5 shown to demonstrate the interface of Ping Alert version 1.2 and it option setting as SMS alert system sample was used by SMS4Mail. The sending process of Ping Alert as well is shown in the same figure as well.

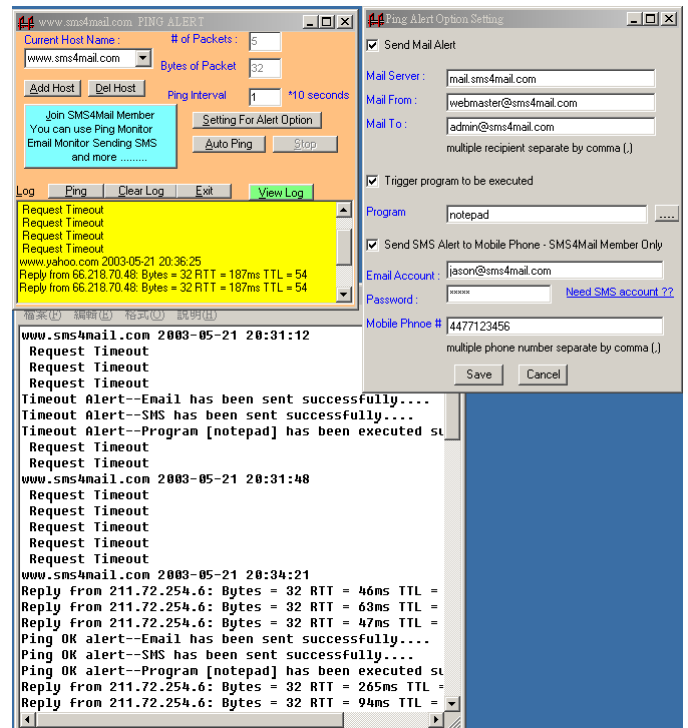

Figure 5: The Interface of Ping Alert version 1.2 and its Option Setting.

### 3.6 SMS4Mail Version 3.1

By referring to the SMS4Mail (n.d.), it states that SMS alert system process will be verifying and filtering user e-mail accounts and then send messages to recipient mobile phone. The SMS4Mail version 3.1 is a new version program by SMS4Mail and it send SMS messages only. This system will involved the POP3 services for e-mail communication protocol and SMS messages may send to multiple mobile phones at the same time. At a time, the SMS alert system enables maximum 160 characters per messages only. This is a sample SMS message that already sent by SMS4Mail:

“F:myFriend@yahoo.com\*Date:Wed, 02 Jan 2002 14:57:16 0800\*S:say hello!!\*B:Dear Amy, Tell you a good program SMSmail,which will check your POP3 account and send SMS

to your mobile phone while you got my mail” (SMS4Mail, n.d.).

Explanation:

F: Sender email ID S: Subject B: Text Body \*: Separator

The following figure 6 was demonstrated the interface of SMS4Mail version 3.1 as SMS alert system sample was used by SMS4Mail.

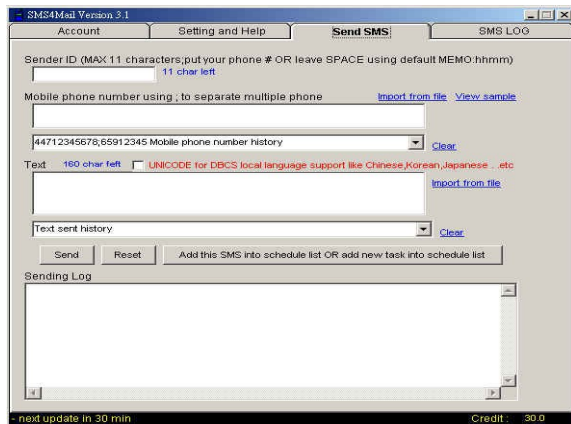

Figure 6: The Interface of SMS4Mail Version 3.1 (SMS4Mail, n.d.).

The following figure 7 shown below demonstrates the common architecture of SMS4Mail services.



Figure 7: The common architecture of SMS4Mail Services (SMS4Mail, n.d.)

## 4.0 DISCUSSIONS

### Academic Environment

There are several parties that involves directly or indirectly in the UUM academic environment such as registrar, bursar, library, internal departments, and colleges. All parties play a

vital roles and always communicating with each other during the academic management process. The figure 8 below shows the general view of relationship among the parties that involve in the academic environment.

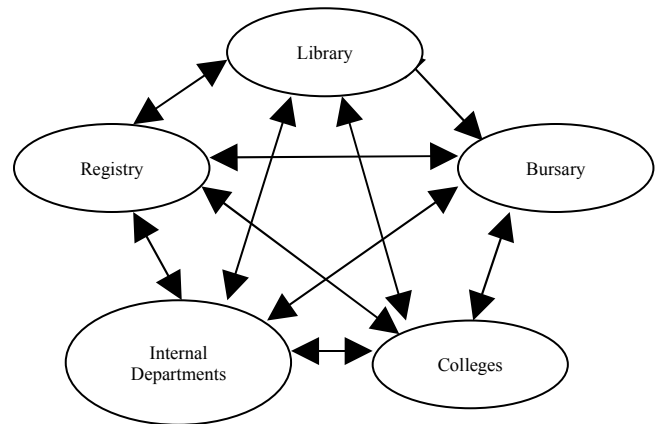

Figure 8: General view of relationship among the parties involved in the UUM academic environment.

The studies will be focusing more on the process of learning and teaching management in the Division of Applied Science (CAS) that will draw the involvement of several parties in the division level such as the division chair, head coordinator, program coordinator, lecturer, instructor, technician, and student themselves. The next figure 9 below shows the relationship between several parties in the division level as already been mentioned before.

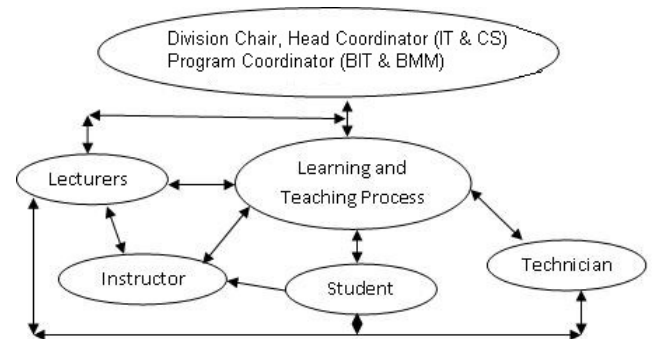

Figure 9: Relationship among the parties of Applied Science division as involve in the process of learning and teaching management.

In teaching and learning process there're four parties that communicate directly with each other which is students, lecturers, instructors, and technicians. This process can be described via the figure 10 below.

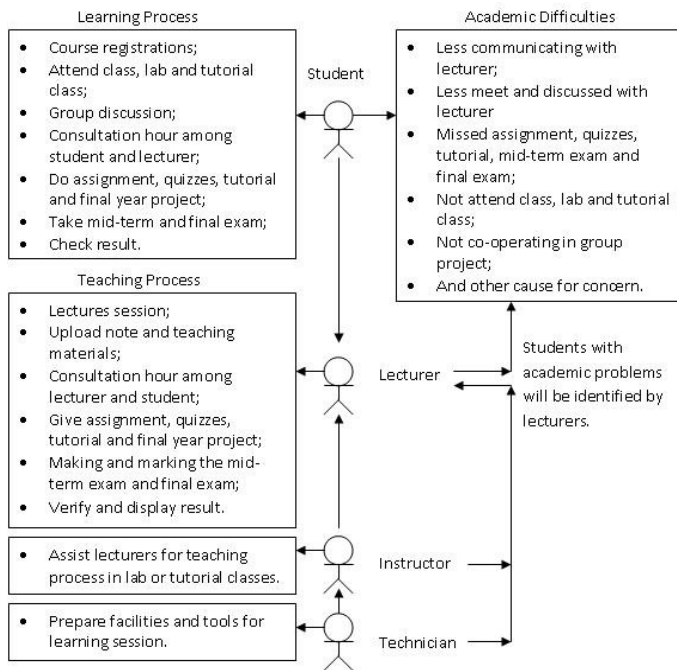

Figure 10: General figure of teaching and learning process in the Division of Applied Science (CAS), Universiti Utara Malaysia.

By referring to the figure above, student's academic problems can easily be identified. Based on this hypothesis, if an alert system has been developed in the academic environment, the student can be reminded about their current academic problem (Issack, S.M., Hosany, M. & Gianeshwar, R., 2006). With the existing alert systems in place, it is found that it can enhance the student's academic achievement during learning and teaching process.

This paper examines the architecture of current SMS alert system as three samples architecture in designing AAS for academic environment. This study helps the researcher to design and draw the illustration of the AAS architecture. In this study only three (3) the SMS Management System have been identified and tested. Firstly Bulk SMS Messaging by Clickatell and secondly Ping SMS and thirdly is SMS4mail version 3.0. Both Ping SMS and SMS4mail are produced by SMS4mail. The characteristics, advantages and disadvantages about these systems were stated in the table 1 below:

Table 1: The Characteristics, Advantage and Disadvantage of SMS Alert System in Current Markets.

Type	Characteristics	Advantage	Disadvantage
<b>Bulk SMS Messaging</b>	<ul style="list-style-type: none"> <li>Web-based application system.</li> <li>Send SMS messages to recipients.</li> </ul>	<ul style="list-style-type: none"> <li>Easy to use and manage the program because it was developed using web-</li> </ul>	<ul style="list-style-type: none"> <li>Maximum 160 characters per message send.</li> <li>User required to purchases</li> </ul>

	<ul style="list-style-type: none"> <li>Online system service by Clicketell.</li> </ul>	<ul style="list-style-type: none"> <li>based application tools like PHP language.</li> <li>Simple to configure/setting up the program, where SMS gateway and host server already set after user register this program.</li> <li>User-friendly Interface and up to date.</li> </ul>	<ul style="list-style-type: none"> <li>using credit cards, PayPal, Wire Transfers, UK Deposit, SA Deposit, Euro Deposit and MoneyBookers.</li> <li>Need Internet connection to access database server and SMS gateway.</li> </ul>
<b>Ping Alert Version 1.2</b>	<ul style="list-style-type: none"> <li>Standalone application system.</li> <li>System can send email or/and SMS messages.</li> </ul>	<ul style="list-style-type: none"> <li>Enable user to send messages using email or SMS.</li> <li>Unlimited characters per message send by user especially send email messages.</li> <li>User can use both method to send messages such as email setting and SMS setting or user can choose either the first or the second method.</li> </ul>	<ul style="list-style-type: none"> <li>Users need to install the SMS4Mail software first before using the system e.g. sending SMS message.</li> <li>Complicated to configure or setting up the program because users have to configure both method if user want to use both method to send messages such as email setting and SMS setting.</li> <li>Need Internet connection to access the host server.</li> </ul>
<b>SMS4Mail Version 3.1</b>	<ul style="list-style-type: none"> <li>Standalone application system.</li> <li>Can only send SMS messages.</li> </ul>	<ul style="list-style-type: none"> <li>Simple to configure the program setting.</li> <li>Simple to send SMS, user just put sender ID, mobile number, text messages and then send it to recipients.</li> <li>Simple to use and manage the</li> </ul>	<ul style="list-style-type: none"> <li>Users need to install the SMS4Mail software first before sending SMS message.</li> <li>Maximum 160 characters per message send.</li> <li>Need Internet connection for access host server.</li> </ul>

		system.	
--	--	---------	--

Based on the above table 1, each of this SMS Management System has its advantages and disadvantages, and these services enable users to send messages to the recipient easier and faster. The characteristics and the architectures of this SMS Management System can be merged into the design of the AAS system architecture in order to suit with academic management environment specifically in the Division of Applied Science (CAS).

## 5.0 CONCLUSIONS

Based on this study, the SMS Management System involved many component and protocols process in the architecture especially to deliver SMS to the recipients. After observing the three of SMS Management System architecture alike Bulk SMS messaging, Ping Alert and SMS4Mail, several characteristics, advantages and disadvantages, component and protocols for mobile communication had been identified and it consist of WAP Gateway, WAP Push Protocol, and WAP Pull Protocol, GSM, GPRS, TCP/IP, WML, WMLScript, Wireless Datagram Protocol (WDP), Wireless Transaction Protocol (WTP), Wireless Session Protocol (WSP), XML Language and other concerning. Based on the observation that has been made on three SMS Management System mentioned above, it can be concluded that the Bulk SMS messaging system architecture will be used as a fundamental guideline to develop the alert system's architecture and will be altered to make it suitable in the academic environment. The reason behind the selected architecture it is because the Bulk SMS messaging system was developed from web based platform and by following its architecture, it is much easier to integrate the system with other existing systems in UUM, especially in the Division of Applied Science -- for instant Learning Care, UUM Portal Community, UUM Web Cube Community and Lecture Attendance System (LeCas). Users do not need to install any software to run the system. If the alert system for academic environment had been developed base on a standalone architecture platform such as Ping Alert and SMS4Mail, it will become complicated because it will require each user to install the alert system's software before using it and it will be difficult to access that system. The study in this field is relatively new in Malaysia educational environment especially in UUM and researchers require more observation and analysis for future direction.

## 6.0 REFERENCES

Nyuk Mee, V., & Selamat, A., (2007), *SMS Management System for Direct Sales and Network Marketing*. In: Fifth

International Conference on Information Technology in Asia 2007 (CITA'07), 10th – 12th July 2007, Hilton Hotel, Kuching, Sarawak, Malaysia.

Issack, S.M., Hosany, M., & Gianeshwar, R., (2006), *A M-E (Mobile-Elearning) Adaptive Architecture to Support Flexible Learnin*. Vol. 3, No.1, pp 19-28. Retrieved February 3, 2009, from Malaysian Online Journal of Instructional Technology (MOJIT).

Mikleia, E., (2006), *Mobile Devices to be applied as supporting tools in Research Methods Class for Undergraduate Student*. Retrieved December 12, 2008, form International Conference on Learning Sciences (ICLS).

IMImobile (2005), *Short messaging service center (SMSC): White paper*. IMImobile: A Division of IMI Software Ltd.

Kannel (n.d.), *Kannel architecture and design*. Retrieved October 26, 2006, from: <http://www.kannel.org/download/1.3.2/arch-1.3.2/arch.html#AEN16>

Clickatell (n.d.), *Bulk SMS messaging*. Retrieved October 23, 2006, from: <http://communicator.clickatell.com/>

Clickatell (2005), *Enabling mobile messaging with OracleAS Wireless and Clickatell*. Retrieved October 23, 2006, from: <http://www.clickatell.com/brochure/oracle.php>

SMS4Mail (n. d.), *SMS4Mail V3.0*. Retrieved November 2, 2006, from: <http://www.sms4mail.com/detaile.htm>